

RACKS

WALL MOUNTED CABINET

[Product Web Page](#)**NS-501GL15U6060**

A WALL MOUNT RACK IS USED FOR RACKING AND PROTECTING NETWORK EQUIPMENT SUCH AS PATCH PANELS AND SWITCHES, BE EASY TO INSTALL.



WALL MOUNT CABINET RACK 15U 60*60

FEATURES

- Single section wall mounted cabinet, front door available for many choices.
- Advanced technology, precise size.
- Reliable structure, static loading capacity: 60KG.
- Quick and easy wall mounted, 19" standard installation.
- Total welded structure.
- 120MM size fan could be installed at top of cabinet.
- Removable side door, can fix lock. Cable entry from top and bottom.
- IP Degrees: IP20.
- Flexible packing methods allows for convenient stocking and end user delivery.
- Multiple sizes available.
- Customization requests welcome.

STANDARD AND MATERIAL

- Comply with ANSI/EIA; RS-310-D; IEC297-2;
- DIN41491: PART1; DIN41494: PART7; GB/T3047.2-92
- Standard, compatible with 19" international
- Standard, metric system and ETSI standard

SURFACE TREATMENT

- Degreasing, pickling, phosphating,
- powder coating.

MATERIAL

- SPCC cold rolled steel.

THICKNESS

- Mounting profile 1.5mm;
- the others: 1.0 to 1.2mm.

COLOR

- Body color: RAL9004 (black); RAL7035

RACK LAYOUT

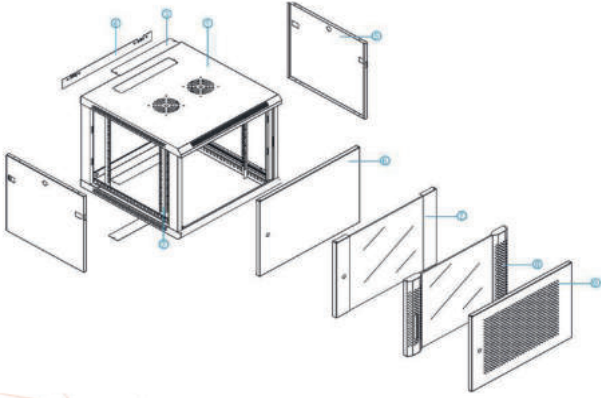

No.	Name	Qty	SPCCT (mm)
1	Frame	1 PCS	1.0
2	Mounting profile	4 PCS	1.5
3	Panel	2 PCS	1.0
4	Hanger	1 PCS	1.5
5	Side door	2 PCS	0.8
6	Metal door	1 PCS (Quantity as request)	1.0
7	Toughened glass door	1 PCS	1.2
8	Toughened glass door with round vented border	1 PCS (Quantity as request)	1.2
6	Hexagonal reticular high density vented plate door	1 PCS (Quantity as request)	1.0

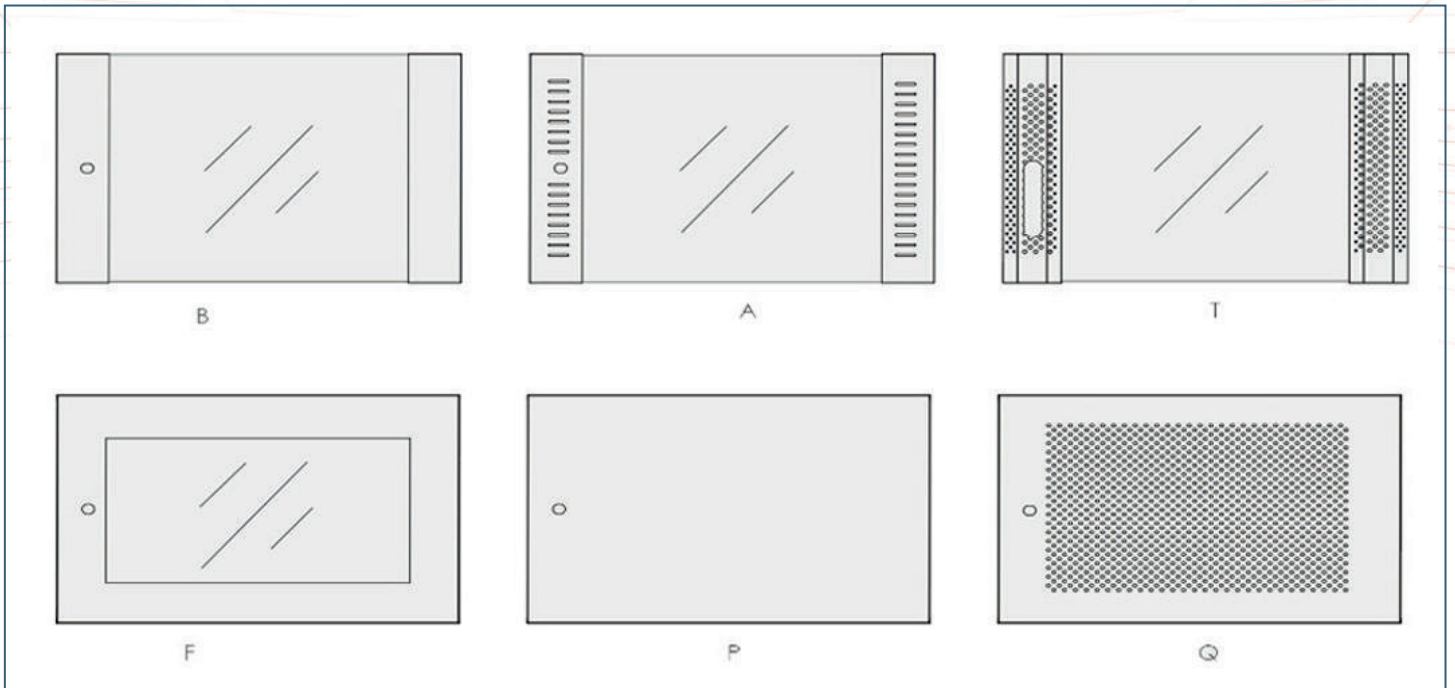

TECHNICAL SPECIFICATION

Model	U	Width	Depth	Height	Flat Packing Size Unit: M	Flat Packing CBM Unit: M
NS-501GL4U6045	4	600	450	274	0.0379	62 × 0.47 × 0.13
NS-501GL4U6060			600		0.0500	62 × 0.62 × 0.13
NS-501GL6U6045	6	600	450	363	0.0379	62 × 0.47 × 0.13
NS-501GL6U6060			600		0.0500	62 × 0.62 × 0.13
NS-501GL9U6045	9	600	450	496	0.0379	62 × 0.47 × 0.13
NS-501GL9U6060			600		0.0500	62 × 0.62 × 0.13
NS-501GL12U6045	12	600	450	629	0.0846	62 × 0.65 × 0.21
NS-501GL12U6060			600		0.0846	62 × 0.65 × 0.21
NS-501GL15U6045	15	600	450	762	0.1016	62 × 0.78 × 0.21
NS-501GL15U6060			600		0.1016	62 × 0.78 × 0.21
NS-501GL18U6045	18	600	450	895	0.1185	62 × 0.91 × 0.21
NS-501GL18U6060			600		0.1185	62 × 0.91 × 0.21

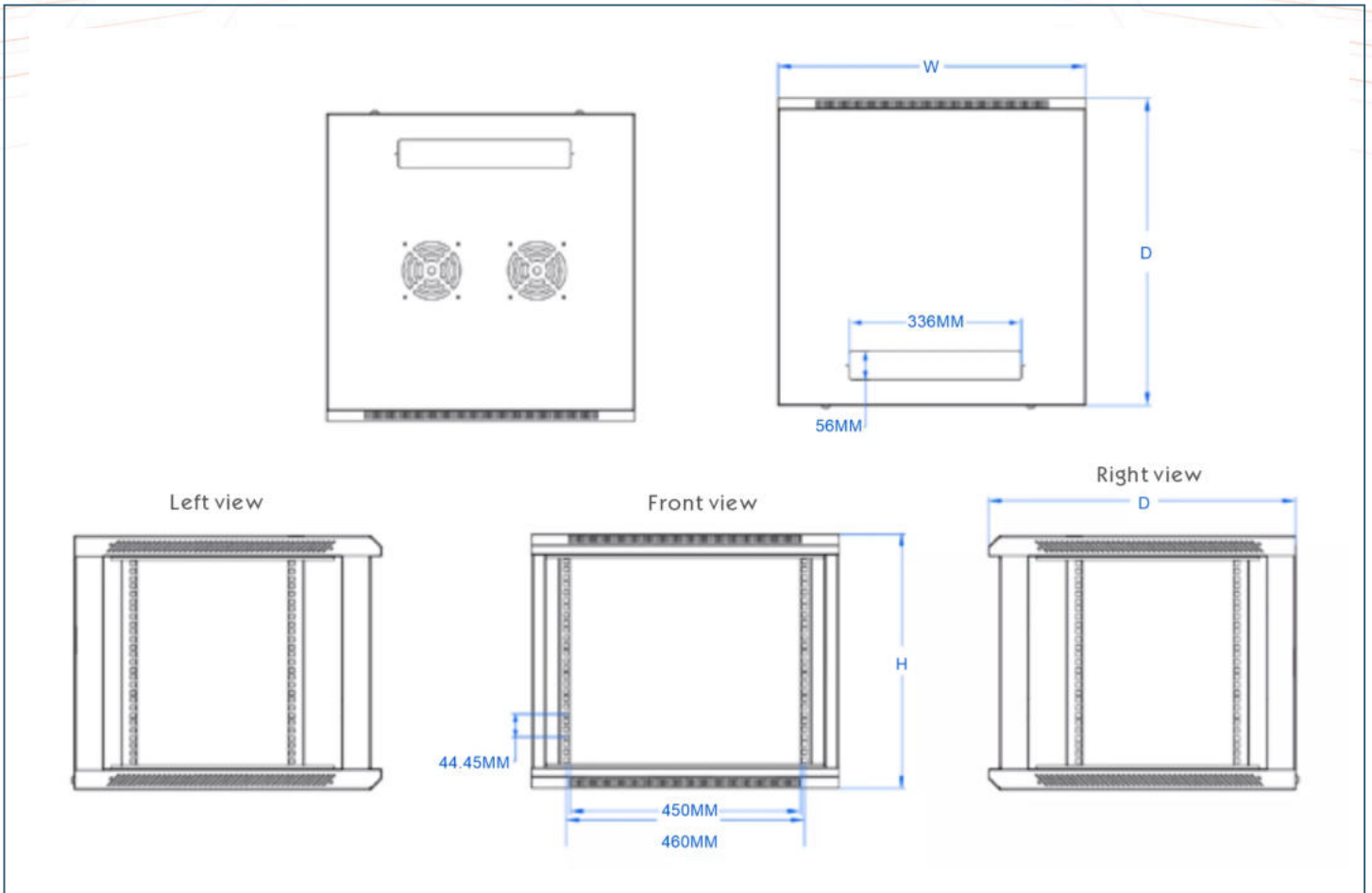

RACK INSTALLATION

