

*Since 1968*

**COMMAX**  
Smart Home & Security

# User Manual

DOOR PHONE DP-201LA



[www.commax.com](http://www.commax.com)

COMMAX Co.,Ltd.



- Thank you for purchasing COMMAX products.
- Please carefully read this User's Guide (in particular, precautions for safety) before using a product and follow instructions to use a product exactly.
- The company is not responsible for any safety accidents caused by abnormal operation of the product.

## 1. Warning and caution

To prevent fire or shock hazard, do not expose the unit to rain or moisture.

 This symbol is intended to alert the user to the presence of uninsulated "dangerous Voltage" within the product's enclosure that may be of sufficient magnitude to constitute a risk of electric shock to persons.

 This symbol is intended to alert the user to the presence of important operating and maintenance (servicing) instructions in the literature accompanying the appliance.



### caution

Risk of electric shock  
do not open



CAUTION : To reduce the risk of electric shock, do not remove cover (or back) no user-serviceable part inside refer servicing to qualified service personnel

## 2. Overview

### Controls and functions

#### ROOM STATION

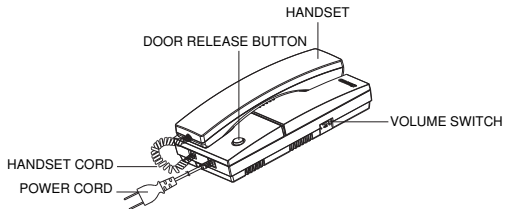

#### DOOR STATION

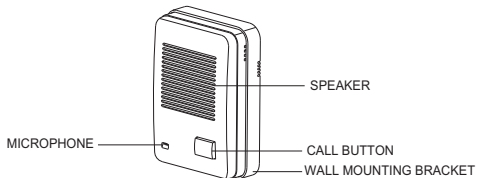

### 3. Operation

1. When the call button(on the door station) is pressed, the chime sounds.
2. Adjust the volume switch(on the room station) to control the call sound.
3. Pick up the handset(on the room station) to talk.
4. Press the door release button(on the room station) to open the door.  
The door-lock should be installed.
5. Place the handset to finish talking.

### 5. Specification

POWER SOURCE	220V~, 50Hz High 300mW across 8 ohm
OUTPUT POWER	Low 50mW across 8 ohm
DISTANCE	100m( $\varnothing$ 0.65mm), 150m( $\varnothing$ 0.8mm)
DIMENSION	208(D) X 98 (W) X 65(H)mm / Room station.
WEIGHT	700g
DOOR-STATION	DR-201D / DR-201H / DR-201A/DR-2R/DR-2L

### 4. Wiring

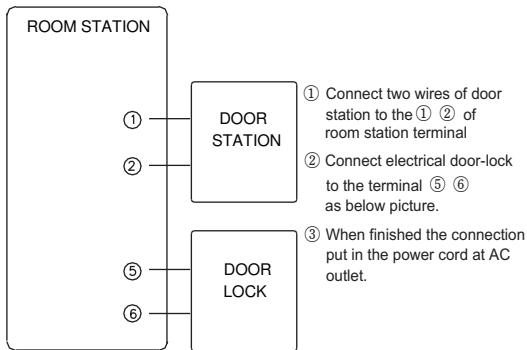

*Since 1968*

**COMMAX**  
SmartHome & Security

# User Manual

DOOR PHONE DP-2S



[www.commax.com](http://www.commax.com)

COMMAX Co.,Ltd.



- Thank you for purchasing COMMAX products.
- Please carefully read this User's Guide (in particular, precautions for safety) before using a product and follow instructions to use a product exactly.
- The company is not responsible for any safety accidents caused by abnormal operation of the product.



## 1. Warnings and Caution

To prevent fire or shock hazard, do not expose the unit to rain or moisture.



This symbol is intended to alert the user to the presence of uninsulated "dangerous Voltage" within the product's enclosure that may be of sufficient magnitude to constitute a risk of electric shock to persons.



This symbol is intended to alert the user to the presence of important operating and maintenance (servicing) instructions in the literature accompanying the appliance.



caution

Risk of electric shock  
do not open



CAUTION : To reduce the risk of electric shock, do not remove cover(or back) no user-serviceable part inside refer servicing to qualified service personnel.



## 2. Overview

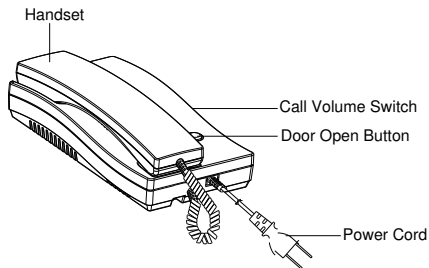

## 3. Operation

### [SUB UNIT]

1. Electric chime call.
2. Back call tone for visitor.
3. Hands free talk within 30cm.

### [MASTER UNIT]

1. Lift up handset and talk when a call's coming.
2. Control a call sound with volume control.
3. Door release button able to open the door.

## 4. Installation

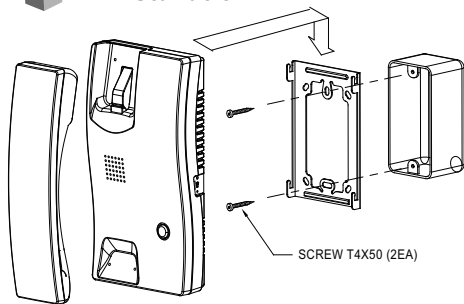

## 6. Specification

Model	DP-2S
Power Source	100/110/120/220/230/240V~, 50/60Hz
Consumption Power	4.5W(MAX)
Distance	100m(∅0.65mm), 150m(∅0.8mm)
Wiring	Call : 2-wire, Door Release : 2-wire(∅ 1.6mm Copper wire)
Dimension(mm)	108(W)°X210(H)°X61.4(D)mm
Weight(g)	640g

## 5. Wiring

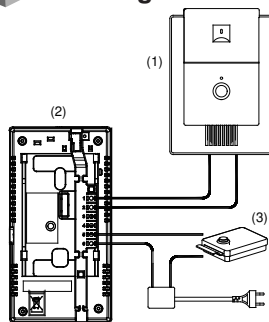

1. Non polarity wiring with Sub Unit(1) and Master Unit (2).
2. Door Release(3) should be provided with additional power source.

*Since 1968*

**COMMAX**  
SmartHome & Security

# User Manual

DOOR PHONE DP-2LD



[www.commax.com](http://www.commax.com)

COMMAX Co.,Ltd.



- Thank you for purchasing COMMAX products.
- Please carefully read this User's Guide (in particular, precautions for safety) before using a product and follow instructions to use a product exactly.
- The company is not responsible for any safety accidents caused by abnormal operation of the product.

## 1. Overview

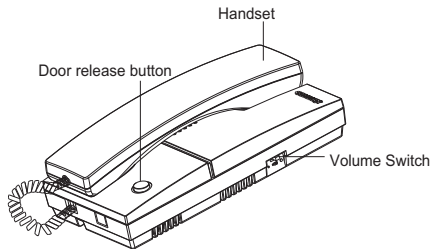

## 2. Operation

1. When the call button(on the door station) is pressed, the chime sounds.
2. Adjust the volume switch(on the room station) to control the call sound.
3. Pick up the handset(on the room station) to talk.
4. Press the door release button(on the room station) to open the door. The door-lock should be installed.
5. Place the handset to finish talking.

## 3. Installation

The unit may also be used with 6V Battery.

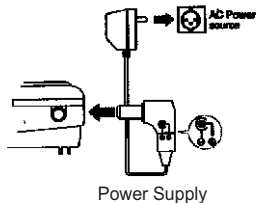
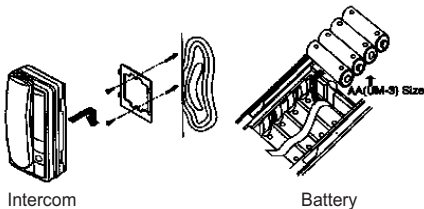

It is required to use Voltage Regulation DC Power Supply(9V or 12V ADAPTER) for safety operation.

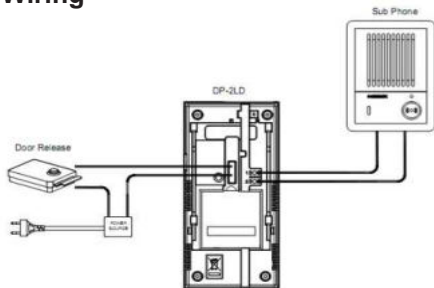

## 4. Wiring



## 5. Specifications

Operating voltage	Battery : 6V  Adapter : 9V or 12V 
Wiring	Door Phone 2-Wire(Nonpolar) Door Release 2-Wire(Nonpolar)
Standby current	0.1mA
Maximum current	50mA
Effective distance	100m (∅ 0.65mm), 150m(∅ 0.8mm)
Dimensions	98(W) x 208(D) x 65(H)mm

*Since 1968*

**COMMAX**  
SmartHome & Security

# User Manual

DOOR STATION DR-2GN / 2GNR



[www.commax.com](http://www.commax.com)

COMMAX Co.,Ltd.



- Thank you for purchasing COMMAX products.
- Please carefully read this User's Guide (in particular, precautions for safety) before using a product and follow instructions to use a product exactly.
- The company is not responsible for any safety accidents caused by abnormal operation of the product.

## 1. Overview

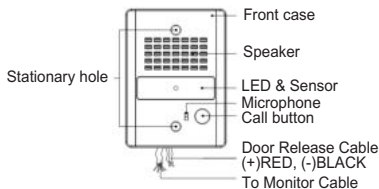

## 3. Specification

MODEL	DR-2GN/2GNR
Wiring system(household)	Door Phone 2-Wire System(Nonpolar)
Communication method	Full Duplex
Rated voltage	9V $\equiv$ (Supplied from the door phone)
Operating Temperature	-10°C ~ +40°C
Dimensions(mm)	93.5(W)X126(H)X18(D)mm
Communication Distance	280g
Weight(g)	170g

## 2. Wiring & Installation

1. Connect Room station cables as appeared in the figure.(polarity with care)
2. Connect Door Release cable as appeared in the figure.  
(applied only for DR-2GNR)
3. Check to see whether the system functions.

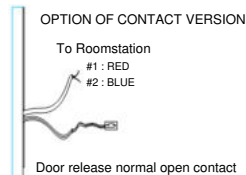
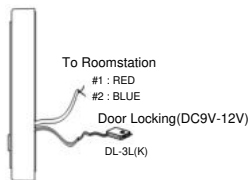

4. If there is no hole on the wall, you can allocate the wire on the groove around the case as appeared in the figure.

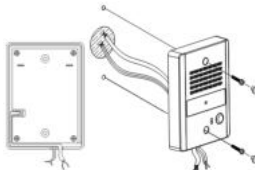

5. Place the system on the wall and mount with screws supplied.

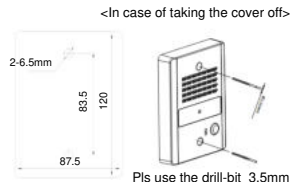

**COMMAX**

**COMMAX Co.,Ltd.**

513-11, Sangdaewon-dong, Jungwon-gu, Seongnam-si, Gyeonggi-do, Korea  
Int'l Business Dept. : Tel.; +82-31-7393-540~550 Fax.; +82-31-745-2133  
Web site : [www.commax.com](http://www.commax.com)

*Printed In Korea / 2016.04.105*